

I-60 Rotors

*A Large Turf Rotor Engineered to Meet
the Demanding Needs of Systems with
Lower Pressures and Smaller Budgets*



TABLE OF CONTENTS

Product Overview	3
Product Features and Benefits	4
Product Comparisons	7
Nozzle Replacement Guide	8
Technical Information	8
Product Performance	9
Installation Details	10
Installation & Arc Adjustment	11
Distribution Analysis (No. 7-20 nozzles)	12
I-60 Replacement Parts	17
Installation Cost Comparisons	18
Precipitation Rate and Run Time Formulas	21

PRODUCT OVERVIEW

How do you bring the cost of irrigating large turf areas down to Earth? Install gear-driven rotors that perform at low pressures with low precipitation rates while creating the most highly efficient water distribution profile. The full-circle I-60-36S and the 40° to 360° adjustable arc I-60-ADS will provide these valuable benefits through Hunter's patented innovative nozzling system—Precision Distribution Control®. With Precision Distribution Control®, our single nozzle design reduces pressure requirements while creating larger droplets that fight the wind and maximize radius. For excellent close-in coverage, gear driven diffuser pins intermittently distribute the stream. The result? Reduced system maintenance and operating costs from large turf rotors engineered to meet the most demanding water and energy conservation needs. Great for low pressure retrofit applications as well. The I-60 rotor is setting new standards for the landscape irrigation industry, as no other 40-65 foot radius rotor can match its outstanding performance at lower operating pressures.

An Easy Choice for Installers

Irrigation installers prefer the I-60 rotor for four simple reasons: it's easy to install, it's easy to adjust, it's guaranteed reliable and it's the best value money can buy.

Installation is easy because of the "through the top" adjustment mechanism allowing modifications to be made quickly and precisely whether the sprinkler is on or off, while the rubber cover protects the adjustment sockets from the intrusion of debris. The industry's #1 continuously improved gear-drive system, coupled with the 3-spring reversing technology, guarantees reliable operation and optimum performance.



*I-60-36S
Full Circle*



*I-60-ADS
Adjustable Arc*

There's no better value on the market than the Hunter I-60 and, with its patented Precision Distribution Control® features and Hunter's years of experience in gear-drive technology, it's no wonder the I-60 rotor has established itself as the professional's choice.



PRODUCT FEATURES AND BENEFITS

Patented Precision Distribution Control®...

Assures even coverage at low pressures

The rotor's single nozzle design features Precision Distribution Control® for reduced turbulence and maximum radius. With gear driven pins that intermittently diffuse the stream, Precision Distribution Control® creates water-efficient performance while it minimizes runoff and waste.



Operates with Lower Working Pressure...

The most power efficient rotor in the industry

Because of its unique nozzle design based on mechanical diffusion, only the I-60 can make the claim that it operates efficiently at low pressures. Large radius rotors (50-65') (15-19.8 m) designed for large turf or landscaped areas require a base pressure in the range of 60-90 psi (3.5-6.2 bars) to reach radius' in the 60 foot (18.2 meter) range. At 40 psi (2.8 bar) the I-60 is able to reach 62' (18.9 m) making it the clear winner for systems without the luxury of higher pressures or for retrofits into systems that have had a reduction in operating pressure over time.

Six Interchangeable Nozzles... Truly uniform coverage and fast identification

With every sprinkler in the I-60 group you get six free interchangeable nozzles that accurately go the distance. The nozzles range from 50-66 feet (15.2-20.1 m) and from 6.5-20.4 gpm (1.48 - 4.63 m³/hr) (24.6 - 77.2 l/min.). Each nozzle is color-coded and numbered for quick and easy identification. The nozzle number indicates the approximate flow rate for the nozzle at 60 psi. The I-60 comes with the #18 nozzle as the standard factory installed nozzle, but can be ordered with any pre-inserted nozzle for convenience and timesaving installation.



Dual Flange I-60-36S Nozzles

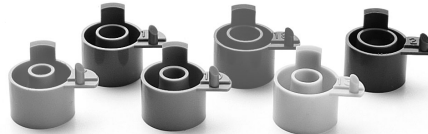

Single Flange I-60-ADS Nozzles

Integral Rubber Cover with Membrane Covered Sockets...

Keeps dirt out, permanently installed

The I-60 combines a small 1³/₄" (10 cm) diameter exposed surface area with a soft rubber cover to make the rotor ideal for play areas. Because the cover is securely attached, it will always give the adjustment sockets the protection of a flexible membrane to keep dirt out.

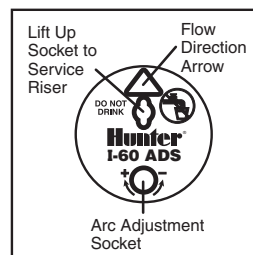

Heavy Duty Spring...

Positive retraction in the harshest conditions

Any turf area is unsafe when sprinklers stay up long after they've quit running. Not only can someone trip over a sprinkler and injure him or herself or break the head that fails to retract, but also rotors like this can become easy targets for vandalism. Because of the extra beefy stainless steel spring, the I-60 rotors retract every time, all the time.

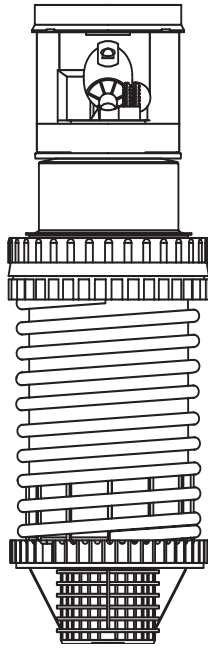

Easy Arc Adjustment...

For fastest, hassle-free adjustment, wet or dry, up or down

Because of its reversing full circle and part-circle operation in one unit, the I-60 Adjustable Arc Rotor (I-60-ADS) is an "all-in-one" sprinkler. With its 40° to 360° Adjustable Arc, most odd shaped areas can be irrigated with a quick turn of the Hunter wrench. The I-60 can be adjusted up or down, wet or dry, for maximum convenience. The 8:1 adjustment ratio changes the arc 45° for each full turn of the wrench and the arrows on the rubber cover clearly define the adjustment direction with plus (+) and minus (-) symbols. Only one rotor is needed to cover those curving walkways and odd-angled turf areas.

Anti-Drain Check Valve...

Saves water, reduces liability

The built-in anti-drain check valve is standard on I-60 rotors. The check valve is designed to keep back a maximum of 10' (3 m) of water pressure. Preventing low head drainage eliminates washouts and wasted water, and may also prevent accidents from occurring and pests from showing up. Also, due to water staying in the pipes, installers may benefit from the reduction of potential surge damage.

Heavy-duty Water Lubricated Gear Drive...

Enduring reliability, year after year

First introduced about 20 years ago and still being continuously improved, the water lubricated gear drive system in the I-60 is patterned after one of Hunter's famous heavy-duty golf rotors, ensuring you with reliability and time proven optimum performance.

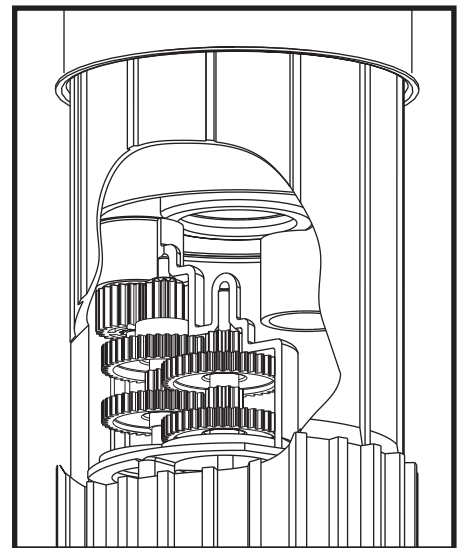

PRODUCT FEATURES AND BENEFITS (CONT.)

Patented V-Stat Self-adjusting Stator...

Drives more power and adds years to sprinkler life

The I-60 requires no specially installed parts or adjustments to ensure constant speed of rotation. With the self-adjusting VStat™, the I-60 is provided up to twice the driving force to the gear drive while adding years to the sprinkler's life. This is accomplished through the stator's patented turbine isolation technology, a breakthrough that all but eliminates gearbox wear due to upward and lateral water thrust.

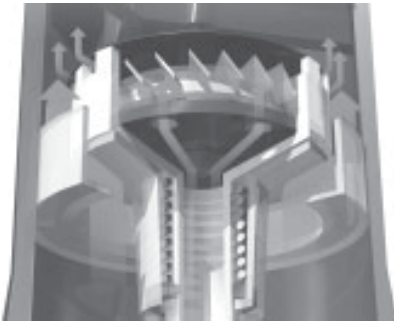

Standard Stainless Steel Riser...

Reliable retraction; longer riser seal life

The I-60's standard stainless steel riser protects the riser and riser seal from scratches and wear due to the increased durability of stainless steel in harsh and sandy soil conditions. Stainless steel eliminates possible scoring on the riser and riser seal, which can lead to premature leaking and unsafe riser "stick-ups."

3-Spring Reversing Mechanism...

Reliability when it's needed

Installers and end-users will have no worries with the most reliable adjustable arc reversing mechanism in the industry. Our patented 3-spring, reversing technology won't hang up and get locked at the critical directional shift point.

5 Year Warranty...

Hunter Industries backs up the products

A full five-year warranty by Hunter communicates to our customers that the I-60 is a rotor that stands up to the environment. The end-user can be assured of a quality product with a guarantee of dependable operation.

Date Coding...

The easy way to identify exactly when your rotor was manufactured

All the Institutional Series Rotors including the I-60 have the manufactured date code stamped on the bottom of the riser stem. The I-60's heavy-duty filter must be removed first to read the code (a flat-blade screwdriver works well for this). The date is stamped with a 4-digit code – the first two digits representing the month, the last two digits indicating the year (e.g., 05 00 stands for May 2000).

PRODUCT COMPARISONS

FEATURES	HUNTER® I-60	TORO® 2001	TORO® 640	RAIN BIRD® Falcon	RAIN BIRD® Talon	NELSON® 7000	NELSON® 7500
Precision Distribution Control®	✓						
50'-62' Radius at 40 psi	✓						
Radius adjustment available	✓		✓	✓		✓	✓
Radius adjustment without disassembly of parts	✓			✓			
Exposed diameter - Less than 2 inches	✓						
Compact design Overall height - Less than 8 1/2 inches	✓						
Vandal resistant, permanent rubber cover	✓	✓	✓	✓			
Nozzles installed without removing parts	✓	✓	✓	✓			
Heavy-duty & coarse buttress threads	✓		✓	✓			
Self adjusting variable stator convenience	✓	✓		✓		✓	✓
"Jar top" convenience with no loose parts to break or special tools required	✓		✓	✓		✓	✓
Patented and proven reliable 3 spring reversing mechanism	✓						
Arc adjustment accomplished without removing parts	✓	✓	N/A	✓	✓		
Adjustable Arc Range (40° -360°)	✓	✓	N/A			✓	✓
Up, down, wet or dry adjustment	✓		N/A	✓	✓	✓	✓
Quick check arc setting	✓		✓	✓	✓		
Check valve check height (up to 10')	✓	✓	✓	✓	✓	✓	✓
Pull-up socket for easy servicing	✓			✓			
Easy to read arc adjustment symbols on top of sprinkler	✓	✓	N/A	✓			
Directional flow indicator, model variation I.D. on top of sprinkler	✓			✓			
Stainless steel riser as standard	✓		✓		✓		✓
Optional reclaimed water versions	✓	✓	✓	✓	✓	✓	✓
Water lubricated gear drive	✓	✓	✓	✓	✓	✓	✓

Toro® is a registered trademark of the Toro Company
 Rain Bird® is a registered trademark of Rain Bird Sprinkler Manufacturing Corp.
 Nelson® is a registered trademark of L.R. Nelson Corporation

NOZZLE REPLACEMENT GUIDE

To Replace: <i>Rainbird Falcon</i>	Use I-60 Nozzle	To Replace: <i>Nelson 7000 & 7500</i>	Use I-60 Nozzle
6 (Lt. Blue) →	7 (Orange)	1 →	7 (Orange)
8 (Dk. Green) →	10 (Green)	2 →	10 (Green)
10 (Gray) →	13 (Lt. Blue)	3 →	13 (Lt. Blue)
12 (Beige) →	15 (Gray)	4 →	15 (Gray)
14 (Lt. Green) →	15 (Gray)	5 →	18 (Red)
16 (Dk. Brown) →	18 (Red)	6 →	20 (Dk. Brown)
18 (Dk. Blue) →	20 (Dk. Brown)	To Replace: <i>Toro 2001</i>	Use I-60 Nozzle
To Replace: <i>Rainbird Talon</i>	Use I-60 Nozzle	6 (Yellow) →	10 (Green)
12 (Red) →	10 (Green)	9 (Red) →	13 (Lt. Blue)
14 (White) →	15 (Gray)	12 (Brown) →	15 (Gray)
16 (Blue) →	20 (Dk. Brown)	18 (Black) →	18 (Red)
To Replace: <i>Rainbird R-70</i>	Use I-60 Nozzle	24 (Blue) →	20 (Dk. Brown)
9 (Orange) →	10 (Green)	To Replace: <i>Toro 640</i>	Use I-60 Nozzle
12 (Beige) →	15 (Gray)	40 →	10 (Green)
15 (White) →	20 (Dk. Brown)	41 →	13 (Lt. Blue)
18 (Blue) →	20 (Dk. Brown)	42 →	15 (Gray)
To Replace: <i>Rainbird "Other"</i>	Use I-60 Nozzle	43 →	18 (Red)
41-51A 14x11 →	20 (Dk. Brown)	44 →	20 (Dk. Brown)
47A 16 →	18 (Red)	To Replace: <i>Toro 610</i>	Use I-60 Nozzle
37A 14 →	10 (Green)	6 →	10 (Green)
6060 13x11 →	18 (Red)	9 →	13 (Lt. Blue)
5055 14 →	10 (Green)	12 →	15 (Gray)
65 Series 16 →	18 (Red)	15 →	18 (Red)
To Replace: <i>Thompson 186/187</i>	Use I-60 Nozzle	To Replace: <i>All Mfg. Single Nozzle Impacts</i>	Use I-60 Nozzle
P-Nozzle →	7 (Orange)	$\frac{3}{16}$ " →	7 (Orange)
Q-Nozzle →	10 (Green)	$\frac{13}{64}$ " →	10 (Green)
R-Nozzle →	15 (Gray)	$\frac{7}{32}$ " →	10 (Green)
S-Nozzle →	18 (Red)	$\frac{15}{64}$ " →	13 (Lt. Blue)
T-Nozzle →	20 (Dk. Brown)	$\frac{1}{4}$ " →	18 (Red)
		$\frac{17}{64}$ " →	20 (Dk. Brown)

TECHNICAL INFORMATION

MODELS

I-60-ADS – Adjustable arc (40°–360°)
I-60-36S – Full circle

DIMENSIONS

- Pop-up height: 3" (8 cm)
- Overall height: 8 $\frac{3}{8}$ " (21 cm)
- Female inlet: 1" NPT or BSP
- Exposed diameter: 1 $\frac{3}{4}$ " (10 cm)

OPERATING SPECIFICATIONS

- I-60-ADS • Discharge rate: 6.5 to 20.4 gpm (1.48 to 4.63 m³/hr; 24.6 to 77.2 l/min)
- Radius: 50' to 66' (15.2 to 20.1 m)
 - Pressure range: 40 to 60 psi (2.8 to 4.1 bars; 275 to 413 kPa)
 - Precipitation rates*: approximately .29" to .52" (7 mm to 13 mm) per hour
 - Nozzle trajectory: 25°

- I-60-36S • Discharge rate: 6.5 to 20.8 gpm (1.48 to 4.72 m³/hr; 24.6 to 78.7 l/min)
- Radius: 51' to 67' (15.5 to 20.4 m)
 - Pressure range: 40 to 60 psi (2.8 to 4.1 bars; 275 to 413 kPa)
 - Precipitation rates*: approximately .25" to .55" (6 mm to 14 mm) per hour
 - Nozzle trajectory: 25°

OPTIONS AVAILABLE

- Reclaimed water cover
- Factory-installed nozzles

* Calculated for 360° sprinkler

PRODUCT EXPLANATION

EXAMPLE: **I-60 - ADS - 18**

MODEL
I-60 = 3" Pop-up

FEATURES
ADS, 36S
ARS, 3RS

OPTIONS
XX = Complete Set of Nozzles
7-20 = Factory-Installed Nozzle Number
B = BSP Thread

PRODUCT PERFORMANCE

I-60-36S Full Circle Performance Chart			
Color Coded Nozzles	PSI	Radius ft.	GPM
7 Orange	40	51'	6.5
	50	54'	7.5
	60	56'	8.0
10 Lt. Green	40	53'	8.5
	50	56'	9.5
	60	58'	10.2
13 Lt. Blue	40	56'	10.5
	50	58'	12.4
	60	60'	13.0
15 Gray	40	58'	12.5
	50	60'	14.0
	60	62'	15.1
18 Red*	40	59'	15.6
	50	62'	17.7
	60	65'	18.9
20 Dk. Brown	40	62'	17.5
	50	64'	19.1
	60	67'	20.8

I-60-36S Full Circle Performance Chart – Metric				
Color Coded Nozzles	Pressure Bars	kPa	Radius m	Flow m ³ /hr. l/min
7 Orange	2.8	275	15.5	1.48 24.6
	3.4	344	16.5	1.70 28.4
	4.1	413	17.1	1.82 30.3
10 Lt. Green	2.8	275	16.2	1.93 32.2
	3.4	344	17.1	2.16 36.0
	4.1	413	17.7	2.32 38.6
13 Lt. Blue	2.8	275	17.1	2.39 39.7
	3.4	344	17.7	2.82 46.9
	4.1	413	18.3	2.95 49.2
15 Gray	2.8	275	17.7	2.84 47.3
	3.4	344	18.3	3.18 53.0
	4.1	413	18.9	3.43 57.2
18 Red*	2.8	275	18.0	3.54 59.1
	3.4	344	18.9	4.02 67.0
	4.1	413	19.8	4.29 71.5
20 Dk. Brown	2.8	275	18.9	3.98 66.2
	3.4	344	19.5	4.34 72.3
	4.1	413	20.4	4.72 78.7

I-60-ADS Part Circle Performance Chart			
Color Coded Nozzles	PSI	Radius ft.	GPM
7 Orange	40	50'	6.5
	50	52'	7.1
	60	54'	7.7
10 Lt. Green	40	53'	8.5
	50	56'	9.5
	60	58'	10.2
13 Lt. Blue	40	56'	10.5
	50	58'	12.1
	60	60'	13.0
15 Gray	40	58'	12.5
	50	60'	13.9
	60	62'	15.1
18 Red*	40	59'	15.6
	50	62'	17.5
	60	65'	18.6
20 Dk. Brown	40	62'	17.5
	50	64'	19.1
	60	66'	20.4

I-60-ADS Part Circle Performance Chart – Metric				
Color Coded Nozzles	Pressure Bars	kPa	Radius m	Flow m ³ /hr. l/min
7 Orange	2.8	275	15.2	1.48 24.6
	3.4	344	15.9	1.61 26.9
	4.1	413	16.5	1.75 29.1
10 Lt. Green	2.8	275	16.2	1.93 32.2
	3.4	344	17.1	2.16 36.0
	4.1	413	17.7	2.32 38.6
13 Lt. Blue	2.8	275	17.1	2.39 39.7
	3.4	344	17.7	2.75 45.8
	4.1	413	18.3	2.95 49.2
15 Gray	2.8	275	17.7	2.84 47.3
	3.4	344	18.3	3.16 52.6
	4.1	413	18.9	3.43 57.2
18 Red*	2.8	275	18.0	3.54 59.1
	3.4	344	18.9	3.98 66.2
	4.1	413	19.8	4.23 70.4
20 Dk. Brown	2.8	275	18.9	3.98 66.2
	3.4	344	19.5	4.34 72.3
	4.1	413	20.1	4.63 77.2

Data represent test results in zero wind. Adjust for local conditions.

*Standard nozzle installed.

Pressure, flow rate and radius data for this product were determined and listed in accordance with ASAE Standard S3981.

To measure pressure at the nozzle of a I-60 or any rotor sprinkler, order Hunter rotor pressure gauge kit part # 122900.

INSTALLATION DETAILS

Installation Height

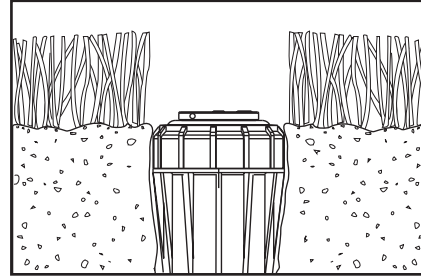

The I-60 sprinkler should be installed at finish grade as shown in the illustration.

Installation Detail

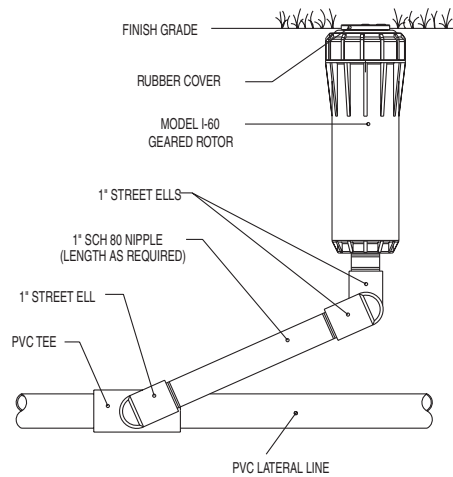

Hunter® I-60 GEAR DRIVE
I-60SWING.

INSTALLATION & ARC ADJUSTMENT

I-60-36S Riser Assembly

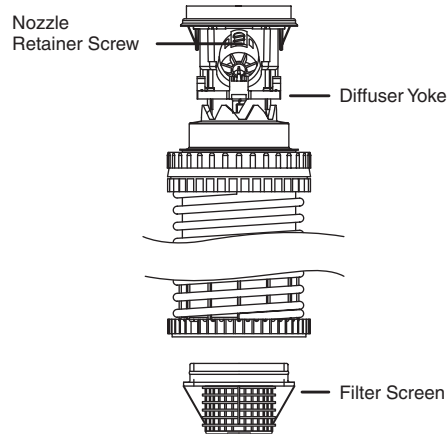

I-60-ADS Riser Assembly

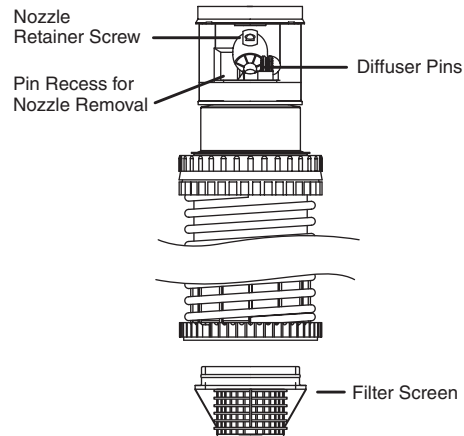

NOZZLE INSTALLATION

Tools needed: T-handle tool p/n 319100, riser service tool p/n 279100, Hunter wrench or $3/32$ " Allen.

Preparation

Unscrew the body cap from the body of the sprinkler. Remove the body cap. Using the key end of the Hunter wrench, pull up on the riser assembly to remove it from the body.

Remove the filter screen. Place the riser assembly's lower end into the base of riser service tool p/n 279100. Press the tool's metal bar down over the riser spring. Continue compressing the spring until the bar enters the slots in the tool's base. Rotate the bar to engage with the tool's base, thereby holding the spring under tension.

Nozzle Removal and Replacement

I-60-36S: The nozzle is retained in the nozzle housing by a setscrew. To remove the nozzle, back out the setscrew so that the nozzle will clear. Rotate the nozzle housing to place the diffuser yoke at its lowest position in order to provide clearance. Grasp a nozzle tab with pliers and pull to remove.

I-60-ADS: The nozzle is retained in the nozzle housing by a setscrew. To remove the nozzle, first slide the diffuser pins to the extreme left, from the viewer's perspective, past the black stop post.

All Models: Place the replacement nozzle in the housing. Press firmly to fully seat the nozzle so that it will clear the retaining setscrew. This can be accomplished with the T-handle tool's open end. Run the setscrew down to retain the nozzle, taking care not to run it down so far as to interfere with the nozzle stream. For I-60-ADS models, ensure the diffuser pins are placed back in line with the nozzle.

Visually check for proper assembly of nozzles and setscrews. Reverse the preparation procedure to reassemble the unit.

Arc Adjustment

All I-60-ADS adjustable arc sprinklers are preset at approximately 180°. Sprinklers may be adjusted with water on or off. It is recommended that initial adjustment be made before installation.

1. Using the palm of your hand, rotate the nozzle turret counterclockwise to the left stop to complete any interrupted rotation cycle (Fig. 2).
2. Rotate the nozzle turret clockwise to the right stop. This is the fixed side of the arc. The nozzle turret must be held in this position for all arc adjustments.

To increase arc:

1. Insert the key end of the Hunter wrench into the adjustment socket (Fig. 1 and Fig. 3).
2. While holding the nozzle turret at the right stop, turn the wrench clockwise. Each 360° turn of the wrench increases the arc 45°.
3. Adjust to any arc between 40°–360°.
4. Wrench will stop turning, or there will be a ratcheting noise, when the maximum arc (360°) is reached.

To decrease arc:

1. Insert the key end of the Hunter wrench into the adjustment socket (Fig. 1 and Fig. 3).
2. While holding the nozzle turret at the right stop, turn the wrench counterclockwise. Each 360° turn of the wrench decreases the arc 45°.
3. Adjust to any arc between 40°–360°.
4. Wrench will stop turning, or there will be a ratcheting noise, when the minimum arc (40°) is reached.

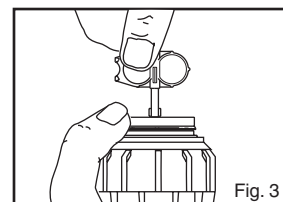
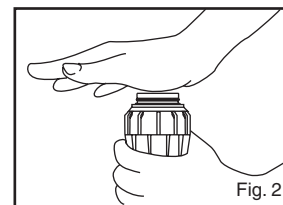
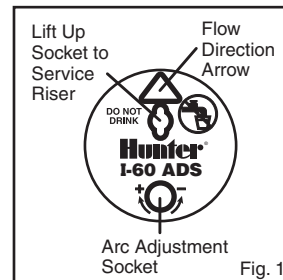

DISTRIBUTION ANALYSIS

Hunter's Testing Philosophy

The following five sets of distribution analysis for the new I-60 are from Hunter's state-of-the-art testing lab. Hunter Industries routinely submits products to The Center for Irrigation Technology for independent testing. We use CIT's test results to verify our own and to make our performance available to the public through their computer software programs. All nozzles for the new I-60 are tested by CIT. The examples below coincide with the five nozzles that are shipped with each sprinkler at 40 & 50 psi respectively.

I-60 Nozzle #7

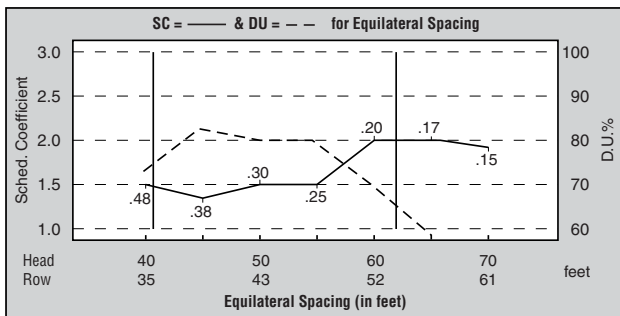
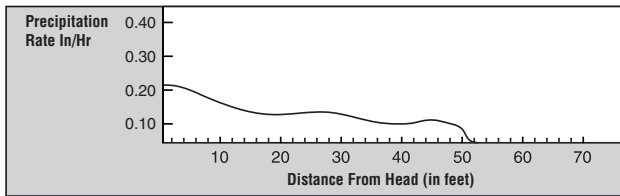

Model: I-60-36S
Nozzle: 7 (orange)
Flow: 6.75 GPM
Pressure: 40 PSI
SOR: 2:41 min.
Radius: 49 feet

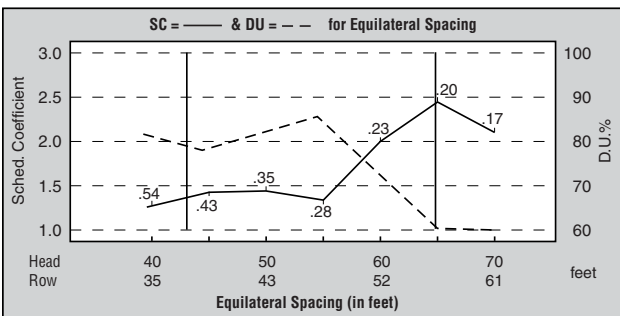
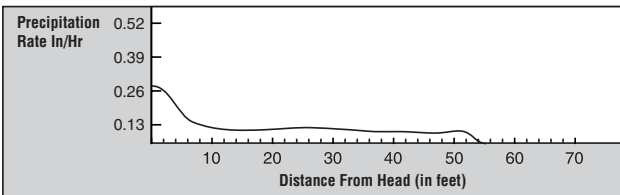

Model: I-60-36S
Nozzle: 7 (orange)
Flow: 7.64 GPM
Pressure: 50 PSI
SOR: 2:39 min.
Radius: 53 feet

Data Interpretation

The upper portion of each report shows the water distribution profile for the sprinkler along with flow, pressure, speed of rotation and radius information. The lower portion is dedicated to efficiency and precipitation rate analysis. To read the graph, first note the spacing range at the bottom. These are the reference points when looking for efficiency at a specific spacing. The lower solid bar that has the numbers above it is the Scheduling Coefficient (SC) line. The numbers above this line reference the precipitation rate in inches per hour at each spacing. To find the SC at your spacing, reference the vertical numbers on the left. SCs of less than 2 are considered good and less than 1.5 are considered excellent. The dashed line along the top is the Distribution Uniformity (DU) line. The DU rating is expressed as a percentage which serves as an indicator of the uniform of water application to a given area of sprinklers, spaced in a triangular pattern.

I-60 Nozzle #10,13

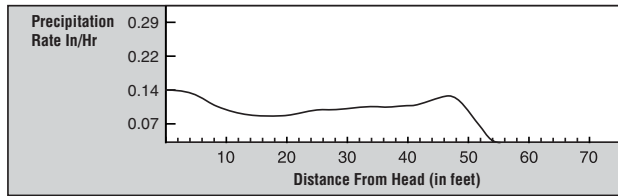

Model: I-60-36S
Nozzle: 10 (green)
Flow: 8.96 GPM
Pressure: 40 PSI
SOR: 2:37 min.
Radius: 55 feet

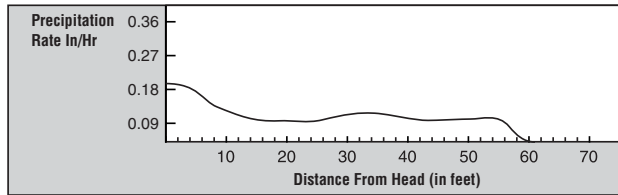
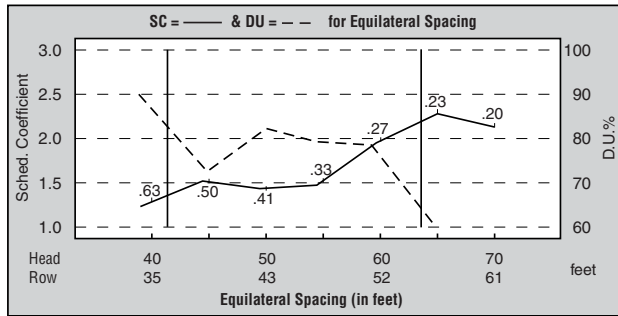

Model: I-60-36S
Nozzle: 10 (green)
Flow: 10.16 GPM
Pressure: 50 PSI
SOR: 2:36 min.
Radius: 59 feet

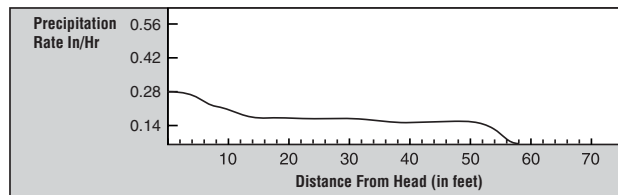
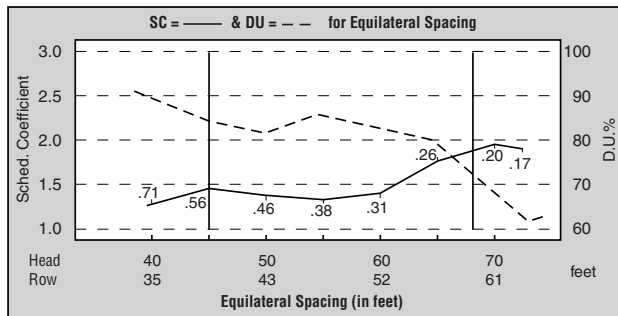

Model: I-60-36S
Nozzle: 13 (blue)
Flow: 11.12 GPM
Pressure: 40 PSI
SOR: 2:37 min.
Radius: 55 feet

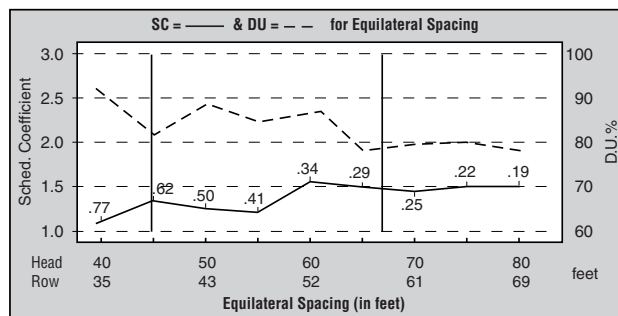

DISTRIBUTION ANALYSIS

I-60 Nozzle # 13, 15

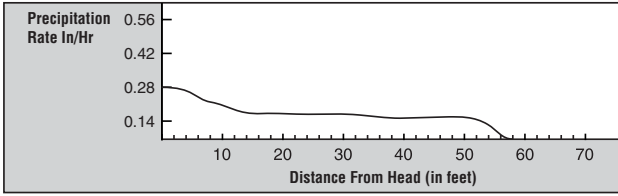

Model: I-60-36S
Nozzle: 13 (blue)
Flow: 12.69 GPM
Pressure: 50 PSI
SOR: 2:35 min.
Radius: 59 feet

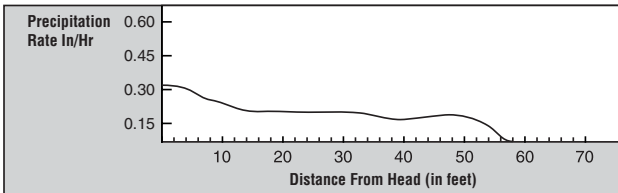
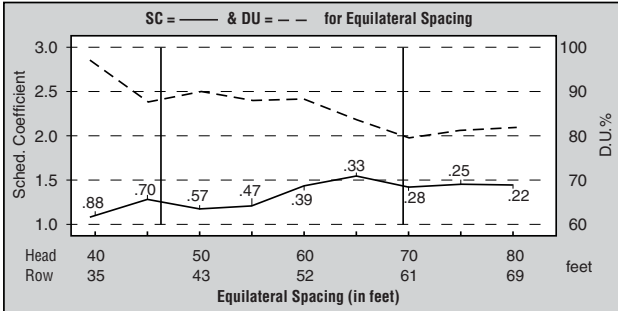

Model: I-60-36S
Nozzle: 15 (gray)
Flow: 13.37 GPM
Pressure: 40 PSI
SOR: 2:34 min.
Radius: 55 feet

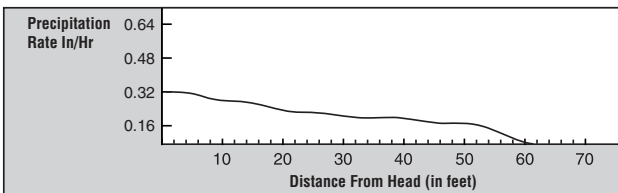
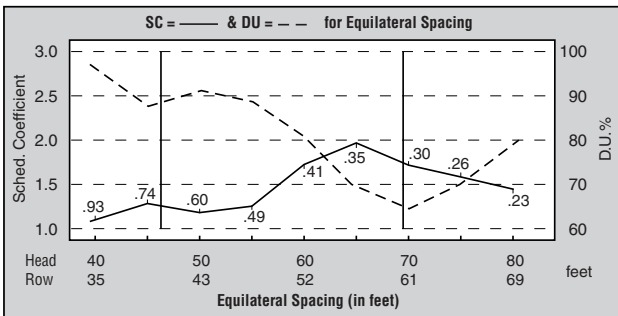

Model: I-60-36S
Nozzle: 15 (gray)
Flow: 15.28 GPM
Pressure: 50 PSI
SOR: 2:34 min.
Radius: 61 feet

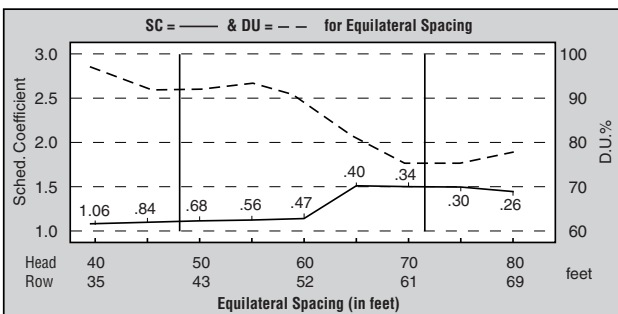

I-60 Nozzle # 18

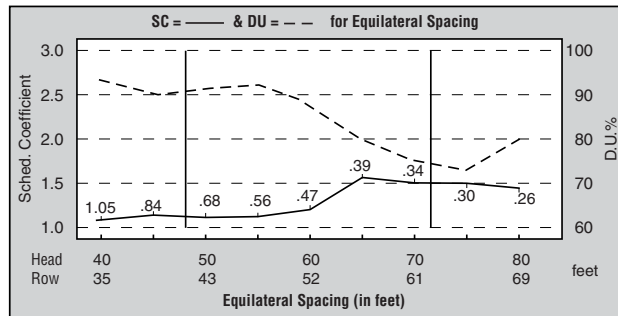
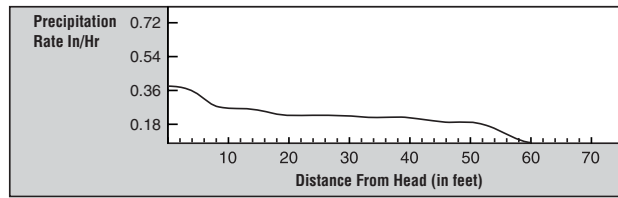

Model: I-60-36S
Nozzle: 18 (red)
Flow: 15.16 GPM
Pressure: 40 PSI
SOR: 2:10 min.
Radius: 59 feet

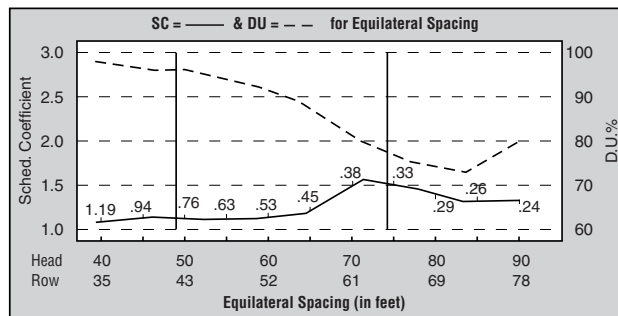
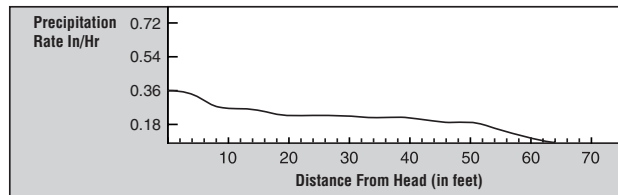

Model: I-60-36S
Nozzle: 18 (red)
Flow: 17.13 GPM
Pressure: 50 PSI
SOR: 2:34 min.
Radius: 63 feet

DISTRIBUTION ANALYSIS

I-60 Nozzle # 20

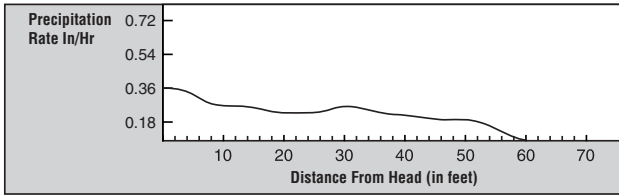

Model: I-60-36S
Nozzle: 20 (brown)
Flow: 16.43 GPM
Pressure: 40 PSI
SOR: 2:32 min.
Radius: 57 feet

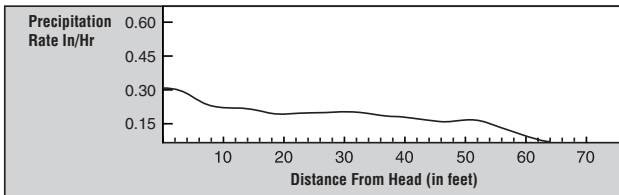
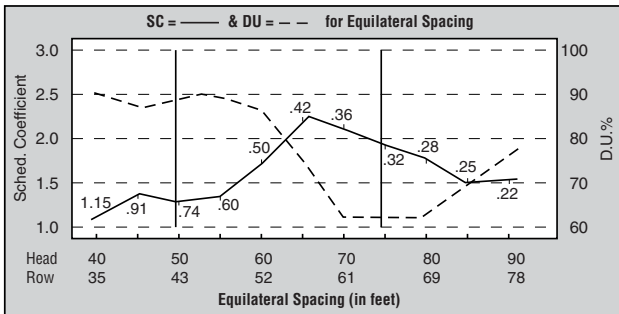

Model: I-60-36S
Nozzle: 20 (brown)
Flow: 19.05 GPM
Pressure: 50 PSI
SOR: 2:31 min.
Radius: 61 feet

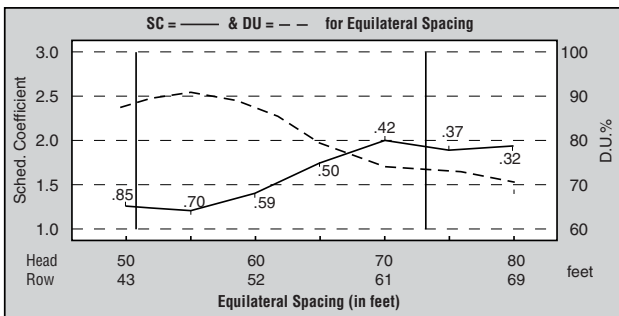

I-60: GEAR-DRIVEN SPRINKLERS REPLACEMENT PARTS

Item	Description	Part No.	
①	Body Cap Assembly	431700	
②	Rubber Cover Screw (2 Required)	334000	
③	Rubber Cover Assembly	ADS (Black)	420300
		36S (Black)	420400
		ARS (Purple)	420305
		3RS (Purple)	420405
④	Riser Assembly <i>Includes Riser, Retractor Spring, Spring Seat, Seal, Filter Screen and Rubber Cover</i>	ADS	432020
		36S	431820
		ARS	432120
		3RS	431920
⑤	Filter Screen Assembly (with Check Valve)	422200	
⑥	Body	NPT	420600
		BSP	420605
⑦	Nozzle Package <i>Includes 7, 10, 13, 15, 18, 20</i>	ADS	462373
		36S	462374

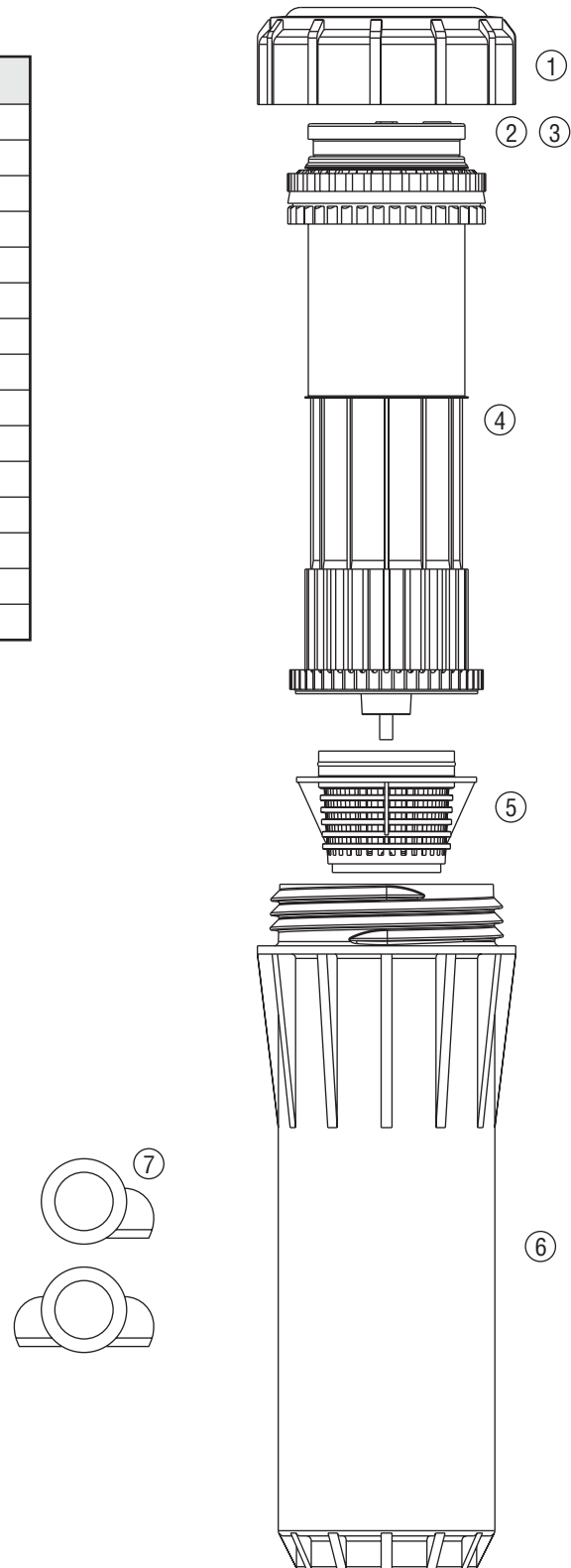

INSTALLATION COST COMPARISONS

HOW THE I-60 STACKS UP AGAINST OTHER ROTORS

To demonstrate the cost savings that the I-60 rotor can provide, we offer two different examples where low water pressure plays a key role in the decision making process. In the first example, an existing community park has seen its water pressure steadily drop over the years as surrounding development has increased. In the second example, a city is trying to determine which size rotor makes the most sense to install in a new park.



With Precision Distribution Control®, a superior watering profile is maintained, even at low pressures.

EXAMPLE 1 RETROFIT INSTALLATION: Existing 2.5 Acre City Park

Five years after the original system installation at the site, the zone pressure drops to 40 psi dynamic, due to a substantial increase in surrounding housing density. The entire irrigation system at the park is currently under-performing due to the lower operating pressure.

The city is considering one of the following options as a solution:

1. Booster pump to increase pressure at the park
2. Hunter I-60 Rotor as a replacement for existing rotors

IRRIGATION SPECIFICATIONS:

Original system operating zone pressure	70 psi
New system operating zone pressure	40 psi
Original rotor spacing	62'
Original nozzle size	20 gpm
Total rotors in park	30
100 gpm zones	6

Option 1: Booster Pump	
ESTIMATED COST OF PUMP INSTALLATION	\$ 2,787
YEARLY ELECTRICAL ENERGY COST	\$ 337
YEARLY PUMP MAINTENANCE LABOR OVERHEAD COST	\$ 540
Initial Installation Cost and 1st Year Operating Costs	\$ 3,664

Option 2: I-60 Rotors	
ESTIMATED COST OF ROTOR INSTALLATION	\$2,638
YEARLY ELECTRICAL ENERGY COST	\$ 0
YEARLY ROTOR MAINTENANCE LABOR OVERHEAD COST	\$ 0
Initial Installation Cost and 1st Year Operating Costs	\$2,638

(Cost comparison utilizes prices quoted to a specific city, actual costs may vary by region.)

Conclusion:

In this example, the clear winner is the system retrofitted with I-60 rotors. Not only is the I-60 less expensive to install and maintain the first year, but it does not have any overhead costs attached to it in subsequent years. To install the I-60 rotors into the existing system, the initial costs are approximately \$2,638, after which there are no more costs. The pump installation option costs are approximately \$3,664 for the first year (separated as \$2,787 for initial installation and \$877 for yearly recurring costs). In the first year alone, the pump option will cost \$1,026 more than just installing the I-60 rotors. Also, the yearly costs of a booster pump in the system after the first year will be approximately \$877.

**EXAMPLE 2
NEW DESIGN & INSTALLATION:
New 10-Acre City Park, Specified 100%
Hunter Product**

A city has decided to specify the installation of 100% Hunter product in a new park. The park has 76 psi available static water pressure and two 2" water meters under which the system must be designed. Now, the only question is what type of rotor makes the most sense to install. Under consideration are the I-25 and I-60 rotors. The I-25 rotors must be spaced closer together requiring more heads per acre and, while choosing the I-60 not only means fewer heads covering a greater distance, but also heads that can deliver water more efficiently at the site's low operating pressure.

SPECS.	Option 1: I-60 Rotors	Option 2: I-25 Rotors
AVAILABLE STATIC PRESSURE	76 psi	76 psi
DYNAMIC PRESSURE LOSSES	-36 psi	-36 psi
OPERATING ROTOR PRESSURE	40 psi	40 psi
NOZZLE	12.5 gpm	6.6 gpm
SPACING	58' Equilateral Triangular	44' Equilateral Triangular
ROTORS PER ACRE	16	26
TOTAL ROTORS	160	260
ZONES	20	18
PIPE BETWEEN HEADS	9,280'	11,440'

HUNTER PRODUCT LIST PRICE:

Option 1: I-60 Rotor System		Option 2: I-25 Rotor System	
20 ICV-210G 2" Valve	\$ 2,540	18 ICV-201G 2" Valve	\$ 2,286
160 I-60 Rotors	\$ 14,392	260 I-25 Rotors	\$14,807
1 ICC-8M+16 Controller	\$ 685	1 ICC-8M+16 Controller	\$ 685
TOTAL COST	\$17,617	TOTAL COST	\$17,778

Conclusion:

The cost of Hunter irrigation products needed for this 10-acre park is approximately the same, whether the I-25 or the I-60 option is installed. The difference is only slight, with the I-60 system coming in just \$161 less. Where the real money is saved is in the piping material and the labor to install the complete system. A very rough comparison estimate ratio that is intended to show the amount of material needed for the two systems indicates that the I-25 system will use at least 23% more pipe and fittings than the I-60 system. This ratio is directly linked to material costs. The biggest cost savings show up in the installation costs, with the number of rotors needed (and, therefore, the accompanying cost of labor) being over 62% higher installing the I-25 system as opposed to the I-60 system.





OVERALL CONCLUSION: I-60 IS THE ONE

As both of these examples demonstrate, the I-60 rotor not only delivers high performance, but it does so in an economical manner that other rotors are hard pressed to match. Whether you are dealing with a retrofit application or an entirely new installation of an irrigation system, if you have a landscape that encompasses a large expanse of turf and you are dealing with low operating pressures, no rotor offers a better solution than the new Hunter I-60.

CALCULATIONS

EXAMPLE 1 - RETROFIT/OPTION 1

ESTIMATED WHOLESALE COST OF PUMP INSTALLATION:

5 hp Booster Pump:	\$ 920
Pump Enclosure:	\$ 400
Pump Start Relay:	\$ 45
Flow Switch:	\$ 80
Concrete:	\$ 100
Pipe/Fittings:	\$ 80
Electrical Service/Hookup:	\$ 375
Installation Labor (18 hours):	\$ 787
TOTAL COST:	\$2,787

YEARLY ELECTRICAL ENERGY COST:

Energy use on 5 hp pump (at 69% eff.)	6.723 kW/hour
Electricity cost from Utility Co.	\$ 0.10 kWh.
6.723 kWh x 501.6 operating hrs	3,372.3 kWh
3,372.3 kWh x \$ 0.10 kWh	\$ 337
TOTAL COST:	\$ 337

PUMP RUN TIME CALCULATIONS

Rotor Precipitation Rate = .53 in/hr.	
ET avg. = .27 in/day6 zones x 3.5 hrs/week @ 4 weeks	84.0 hours
ET avg. = .20 in/day6 zones x 2.6 hrs/week @ 4 weeks	62.4 hours
ET avg. = .15 in/day6 zones x 2.0 hrs/week @ 8 weeks	96.0 hours
ET avg. = .12 in/day6 zones x 1.6 hrs/week @ 16 weeks	153.6 hours
ET avg. = .08 in/day6 zones x 1.1 hrs/week @ 12 weeks	105.6 hours
YEARLY PUMP OPERATING TIME	501.6 hours

MATERIAL COST RATIO ESTIMATE:

The I-25 system will require 23.2% more material.

Compare the amount of pipe used for the I-25 system vs. the I-60 system (11,440/9,280' = 1.232).

LABOR COST RATIO ESTIMATE:

The I-25 system will require 62.5% more installation labor hours.

Compare the number of rotors needed for the I-25 system vs. the I-60 system (260/160 = 1.625).

CALCULATIONS

EXAMPLE 1 - RETROFIT/OPTION 2

ESTIMATED WHOLESALE COST OF ROTOR INSTALLATION:

30, I-60 Rotors:	\$1,888
Labor Cost (\$25 per rotor):	\$ 750
TOTAL COST:	\$2,638

CALCULATIONS

EXAMPLE 2 - NEW DESIGN

APPROXIMATE SYSTEM PRESSURE LOSS COMPUTATIONS:

2" Meter (100 gpm max.)	8 psi max. loss
3" CL 200 Service Main-90' length,	1 psi loss
2" Reduced Pressure Backflow	13 psi loss
3" CL 200 Main-500' length	4 psi (0.8 psi/100') loss
2" ICV Valve (100 gpm)	4 psi loss
PVC Laterals	3 psi loss
PVC Fittings/Misc.	3 psi loss
TOTAL LOSSES:	36 psi loss.

PIPE BETWEEN HEADS:

For I-60 system: 58' pipe between each head x 160 rotors = 9,280 feet of pipe.
 For I-25 system: 44' pipe between each head x 260 rotors = 11,440 feet of pipe.

PRECIPITATION RATE FORMULA

Two formulas are shown below, the first is most useful when comparing precipitation rates between different types of sprinklers or calculating precipitation rates on areas with a single type of sprinkler and uniform head and row spacing. The second method is better suited to areas where sprinkler head flows or spacing varies. Metric versions are shown in parenthesis.

Precipitation Rate - Method #1 - Individual Head Method

$$\text{Pr} = \frac{34650 \times \text{GPM (for any arc)}}{\text{Degrees Arc} \times \text{Head Spacing} \times \text{Row Spacing}}$$

$$\text{Pr} = \frac{\text{m}^3/\text{hr (for any arc)} \times 360,000}{\text{Degrees of arc} \times \text{Head spacing (m)} \times \text{Row Spacing (m)}}$$

$$\text{Pr} = \frac{\text{l/min (for any arc)} \times 21,600}{\text{Degrees of arc} \times \text{Head spacing (m)} \times \text{Row Spacing (m)}} \text{ mm/hr}$$

Where:

Pr	=	precipitation rate in inches per hour
GPM	=	flow for a given sprinkler of any arc, in gallons per minute
Degrees Arc	=	the arc of the given sprinkler in degrees
Head Spacing	=	the space between the heads in a row, in feet
Row Spacing	=	the space between rows of heads, in feet
34650	=	constant for conversion of area and flow into common units

Example: What is the precipitation rate for a 270 degree sprinkler with 6.8 gpm spaced at 28' by 30'?

$$\text{Pr} = \frac{34,650 \times 6.8}{270 \times 28 \times 30} \qquad \text{Pr} = 1.04 \text{ in./hr.}$$

Precipitation Rate - Method #2 - Total Area Method

$$\text{Pr} = \frac{96.25 \times \text{Total GPM}}{\text{Total Area}} \qquad \left(\text{Pr} = \frac{\text{Total m}^3/\text{hr} \times 1,000}{\text{Total Area (m}^2\text{)}} = \text{mm/hr} \right) \qquad \left(\text{Pr} = \frac{\text{Total l/min} \times 60}{\text{Total Area (m}^2\text{)}} = \text{mm/hr} \right)$$

Where:

Pr	=	precipitation rate in inches per hour
Total GPM	=	total flow from all sprinklers in the given area in gallons per minute
Total Area	=	the given irrigated area in square feet
96.25	=	constant for conversion of area and flow into common units

Example: What is the average precipitation rate for a section of turf 325' by 80' if the total flow from all sprinklers in the area is 112 gpm.

$$\text{Pr} = \frac{96.25 \times 112}{(325 \times 80)} \qquad \text{Pr} = 0.41 \text{ in./hr.}$$

SPRINKLER RUN TIME FORMULA

The sprinkler run time formula calculates the number of minutes required to apply enough water to replace the water lost by evapotranspiration for a specific crop irrigated with a system at a particular precipitation rate and efficiency.

$$T = \frac{60 \times \text{Et}_o \times \text{K}_c}{\text{Pr} \times \text{E}_a}$$

Where:

T	=	sprinkler run time in minutes
Et _o	=	reference evapotranspiration rate, in inches
K _c	=	crop coefficient, percent
Pr	=	precipitation rate of the area, in inches per hour
E _a	=	application efficiency of the system, percent
60	=	Constant for conversion of area, flow, inches per hour and inches per day into common units

Example: Determine the sprinkler run time for an athletic field with an accumulated Et_o of 0.45 inches (0.15"/day for 3 days) and a crop coefficient for the warm season turf of 0.70. The sprinkler precipitation rate is 0.50 in./hr. with an application efficiency of 75%.

$$T = \frac{60 \times 0.45 \times 0.70}{0.50 \times 0.75} \qquad T = 50.4 \text{ min.}$$

NOTES

Hunter®

Hunter Industries Incorporated • The Irrigation Innovators
1940 Diamond Street • San Marcos, California 92069 • TEL: (1) 760-744-5240 • FAX: (1) 760-744-7461
www.HunterIndustries.com

© 2001 Hunter Industries Incorporated
P/N 700696 LIT-292.PDF 6/00