

## I-40 Rotors

*The Best in its Class; High Flow, Long Throw,  
and Built Super-Tough to Withstand  
the Harshest Environments*



## TABLE OF CONTENTS

Product Overview ..... 1

Product Features and Benefits ..... 2

Product Comparisons ..... 5

Nozzle Replacement Guide ..... 6

Product Performance ..... 7

Installation & Maintenance..... 8

Distribution Analysis ..... 9

I-40/41 Replacement Parts..... 12

## PRODUCT OVERVIEW

For parks, sports fields and large commercial sites, only the world's toughest rotors will do. The I-40 is the best in its class. High flow, long throw, and built super-tough for the harshest environments. Along with the two secondary nozzles that offer exceptional mid-range and close-in coverage, the six interchangeable main nozzles give the most efficient coverage possible. Its standard stainless steel riser allows for enduring protection for riser and seal. No flow-by or scoring of plastic risers!

The robust new body design includes heavy-duty cap-to-body threads. Its compact, extra beefy construction includes a ribbed body and cap for even better grip and easy servicing. A brute-strong stainless steel spring works in the worst soils and teams with our factory-installed drain check valve to hold back up to 15 feet (4.6 m) of elevation change. The continuously improved gear drive began as an industry breakthrough and is backed by over a decade of proven reliability. Crowned by an extra-thick heavy-duty rubber cover, this sprinkler will rise to the toughest challenges.

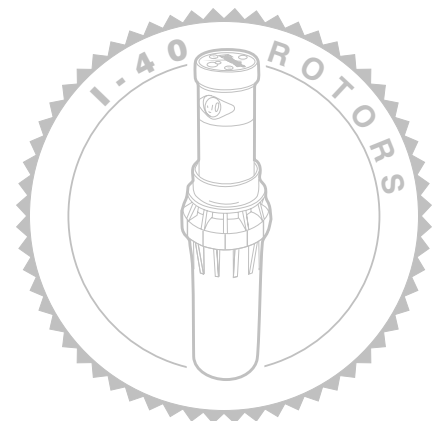

## PRODUCT FEATURES AND BENEFITS

### *Ultimate in Nozzle Efficiency and Performance...*

#### *The triple nozzle system*

With every sprinkler in the I-40 group you get six free interchangeable mainstream nozzles, accurately going the distance up to 74 feet (22.6 m). Two built-in secondary nozzles provide complete mid-range and close-in coverage. Precise, engineered design of the nozzles gives them excellent sprinkler profiles and ensures an even distribution of water.



### *Patented Pressure Port™ System...*

#### *Bigger droplets through the secondary nozzles; excellent close-in coverage*

Providing enough water close to the head had always been a difficult challenge with high flow, high pressure rotors. This is because the tremendous force of the primary stream tends to draw water away from the smaller, secondary nozzle, limiting the efficiency of the nozzles intended for short and medium range coverage.



Now, Hunter's patented Pressure Port system reduces velocity and pressure and increases the droplet size from the secondary nozzles. The result: excellent close-in coverage. The water droplets are larger, making them less affected by the primary nozzle and less likely to be carried away by the wind.

### *Six Interchangeable Nozzles...*

#### *Uniform coverage with a wide range of versatility*

With every sprinkler in the I-40 group you get six free interchangeable primary nozzles, accurately going the distance ranging from 45 to 74 feet (13.7 to 22.6 m) and from 7.0 to 27.5 gpm (1.59 to 6.2 m<sup>3</sup>/hr; 26.5 to 104.1 l/min). Each nozzle has a numbered ID button that can be snapped into the rubber cover for quick and easy identification when the sprinkler is retracted. When pre-inserted nozzles are ordered from the factory, the numbered ID buttons are factory installed.

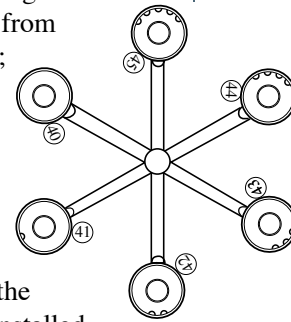

### *ProTech™ Safety System...*

#### *When safety is the primary issue*

The I-40 has the smallest exposed diameter rubber cover in this category of rotors. Couple the safety of the small exposed flat rubber cover with the tapered rubber collar and you have the ProTech safety system — the ultimate in protection whether it be for the child at play in the park or the professional athlete on game day. No hard plastics or metals, only cushioned rubber is next to the playing surface.

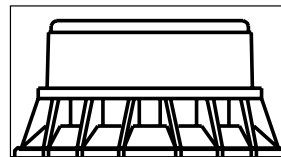

### *Patented VStat® Stator...*

#### *Self adjusting for customer convenience*

The I-40 requires no special instructions to ensure constant speed rotation. With the self-adjusting VStat, the I-40 is provided up to twice the driving force to the gear drive while adding years to the sprinkler's life. This is accomplished through the stator's patented turbine isolation technology, a breakthrough



that all but eliminates gearbox wear due to upward and lateral water thrust.

**Standard Stainless Steel Riser...**  
*Reliable retraction; longer riser seal life*

The standard stainless steel riser protects the riser and riser seal from scratches and wear due to its increased durability in sandy and harsh soil conditions. Stainless steel eliminates possible scoring on the riser and riser seal, which can lead to premature leaking and unsafe riser "stick-ups."



**Extra Thick Ribs on Body and Cap...**  
*Durability with a grip*

With super heavy-duty external ribbing on the body and body cap, the sprinkler can be disassembled and handled with ease, especially when it's wet and muddy!

**Brute Strong Stainless Steel Spring...**  
*Long term positive retraction*

Any playing surface is unsafe when sprinklers stay up long after they've quit running. Because of the extra beefy stainless steel spring, the I-40 rotors retract every time, all the time.

**Drain Check Valve...**  
*Saves water, reduces liability*

The built-in drain check valve is standard in the I-40. The check valve will hold back water pressure for up to 15 feet (4.6 m) of elevation change. Preventing low head drainage prevents accidents, pests, diseases and the wasting of that most valuable resource...water.

**Easy Arc Adjustment...**

*From the top: wet or dry, up or down*

Curving outfields? Dirt skinned areas? Keep the water where it's supposed to go with the adjustable arc. During all phases of installation and maintenance, the 40° to 360° arc is easily fine tuned with a quick turn of the Hunter wrench. An 8:1 adjustment ratio changes the arc 45° for each full turn of the wrench.

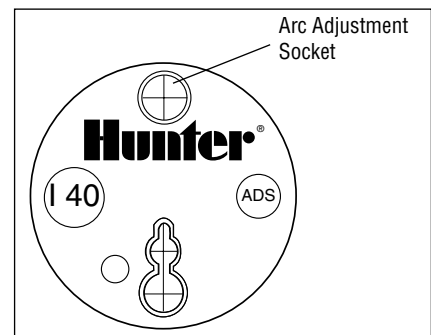

**Patented 3-Spring Reversing...**  
*Reliability when it's needed*

Adjustable arc rotors not only need to rotate, they need to shift directions reliably every time. And, with our patented 3-spring reversing technology, the I-40 will be out there working for you...all the time.

**Spin Weld Nozzle Turret...**  
*Durable in toughest conditions*

With the spin weld process, the rotating nozzle turret is actually welded (not snap-fit) to the bull gear (output tube) of the sprinkler. This welding adds years to the life of the I-40 and extra durability for the acid-test of all sprinklers...the winterization process.

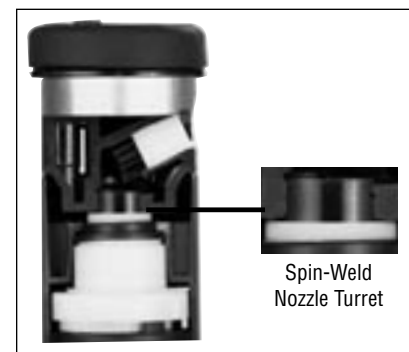

## PRODUCT FEATURES AND BENEFITS *(continued)*

### ***Beefier Gears, Beefier Sprinkler...***

*#1 in reliability*

Hunter is known for having the #1 gear drives in the industry and now the I-40 has beefier gears to withstand the rigors of high flow and high pressures. These new improvements increase life by at least four times, ensuring reliability and time proven, optimum performance.

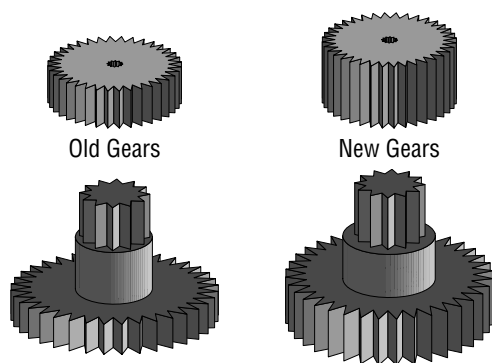

### ***I-42: High Speed Model...***

*When speed is a need*

For quick, light wetdowns of clay tennis courts, baseball infields, or any areas that require dust control or normal turf irrigation, Hunter offers the I-42. The rotation speed for a 360° revolution is increased from three minutes to one, making it perfect for the quick syringing and humidifying of selected areas.

The brown rubber cover on the high speed model, makes for quick and easy identification in the field.

### ***I-40-ON: Opposing Nozzle Model...***

*You'll favor this "opposing" idea*

A reduced version of popular golf type sprinklers, designed specifically for parks, sports fields and public areas. All the same great features as our other I-40 models plus an "opposing" nozzle design where the primary and secondary nozzles are on opposite sides of the nozzle turret and send their streams in opposite directions as the sprinkler rotates.

### ***Turf Cup Kit...***

*When perfection is essential*

The turf cup kit attaches to the popular I-40 rotor and allows grass to actually grow in the top of the sprinkler (out of sight, out of mind). The kit is used on golf greens, grass tennis courts or any area requiring invisible sprinklers and perfect playing surfaces. Order Hunter's turf cup kit (p/n 46-0000) to retrofit current I-40 sprinklers.

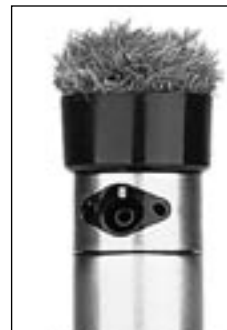

*Note: The turf cup kit will not work with I-40-36S-ON models.*

## PRODUCT COMPARISONS

Features	Hunter I-40	Toro 640	Rain Bird Talon	Nelson 7500
Patented Pressure Port™ secondary nozzle system	✓			
Radius adjustment available	✓	✓		✓
Radius adjustment without disassembly of parts	✓	✓		
Exposed diameter (inches)	2"	2½"	4¾"	2½"
Vandal resistant, permanent rubber cover	✓	✓		
ProTech™ safety system	✓			
Super compact design – overall height	7⅞"	9"	9⅞"	9½"
Nozzles available	6	5	6	6
Nozzles can be installed without removing parts	✓			
Heavy-duty & coarse buttress threads on body cap	✓	✓		
Self adjusting stator increases life and has consistent speed	Patented VStat®			
Self adjusting stator convenience	✓		✓	✓
“Jar top” convenience with no loose parts or special tools required	✓	✓		✓
Patented and proven reliable 3 spring reversing mechanism	✓			
Arc adjustment, without removing parts	✓		✓	
Adjustable Arc Range	40°-360°	12 fixed	30°-345°	40°-360°
Up, down, wet or dry arc adjustment	✓		✓	
Quick check of arc setting	✓	✓	✓	
Check valve check height (feet)	15	15	10	15
Pull-up socket for easy servicing	✓			
Optional reclaimed water versions	✓	✓		✓
Water lubricated gear drive	✓	✓	✓	✓

Rain Bird® is a registered trademark of Rain Bird Sprinkler Manufacturing Corporation  
 Nelson® is a registered trademark of L. R. Nelson Corporation  
 Toro® is a registered trademark of The Toro Company

### SPECIFICATION GUIDE

EXAMPLE: **I-40 - ADS - 43**

MODEL	FEATURES	OPTIONS
I-40, I-41* = 3" Pop-up	ADS, 36S, ARS, 3RS, 36S-ON, 3RS-ON	XX = Standard Set of 5 Nozzles 40 - 45 = Factory-Installed Nozzle Number (Models ADS, 36S, ARS, 3RS)
I-42, I-43* = High-Speed	ADS, 36S, ARS, 3RS	15 - 28 = Factory-Installed Nozzle Number (Models 36S-ON, 3RS-ON)

\* Metric Model Number (BSP Threaded Inlet)

#### KEY TO FEATURES:

**ADS** = Adjustable with Check Valve and Stainless Steel Riser  
**36S** = Full-Circle with Check Valve and Stainless Steel Riser  
**ARS** = Adjustable with Check Valve, Reclaimed Water and Stainless Steel Riser  
**3RS** = Full-Circle with Check Valve, Reclaimed Water and Stainless Steel Riser  
**36S-ON** = Full-Circle, Dual Opposing Nozzle, with Check Valve and Stainless Steel Riser  
**3RS-ON** = Full-Circle, Dual Opposing Nozzle, with Check Valve, Reclaimed Water ID and Stainless Steel Riser

## NOZZLE REPLACEMENT GUIDE

Nozzle Replacement Guide		
To Replace		Use I-40 Nozzle
<b>RAIN BIRD "Other"</b>		
41-51A	18 x 11.5	44
41-51A	13 x 11	43
47A-SAM	16	42
37A	14	41
6060	13 x 11	43
5055	14	41
65 Series	16	42
R70	9	41
R70	12	42
R70	15	43
R70	18	43
R70	21	44
R70	23	45
<b>RAIN BIRD Talon</b>		
14		42
16		43
18		44
20		45
22		45

To Replace		Use I-40 Nozzle
<b>TORO 640/610/630</b>		
<b>640</b>	640-XX-40	40
	640-XX-41	41
	640-XX-42	42
	640-XX-43	43
	640-XX-44	44
<b>610</b>	610-02-12	42
	610-02-15	43
<b>630</b>	634-02-31	42
	634-02-32	43
	634-02-33	44
<b>THOMPSON 186/187</b>		
R-Nozzle		42
S-Nozzle		43
T-Nozzle		43
<b>THOMPSON 188/9</b>		
U-Nozzle		44
V-Nozzle		45
W-Nozzle		45
<b>NELSON 7000 &amp; 7500</b>		
2		40
3		41
4		42
5		43
<b>NELSON 7500</b>		
7		44
8		45
<b>ALL MFG. SINGLE NOZZLE IMPACTS</b>		
15/64"		41
1/4"		42
17/64"		43
9/32"		43

## PRODUCT PERFORMANCE

The I-40 has six interchangeable nozzles that provide a wide and versatile range from 7.0 to 27.5 gpm and 45' to 74' radius. The optimum performance varies between 60 and 80 psi, dynamic operating pressure (depending upon nozzle size).

The average precipitation rate is approximately .40 in./hr. (calculated at 360°). The actual precipitation rate may vary, and should be calculated.

The I-40-ON has six color-coded nozzles and covers a slightly longer radius range (from 54' to 78'). Optimum performance varies between 60 and 90 psi. Across the board, the opposing nozzles also produce a lower precipitation rate than the standard nozzle design. Once again, the actual precipitation rate may vary and should be calculated for accuracy.

I-40 Nozzle Performance Data					
Nozzle	Pressure PSI	Radius ft.	Flow GPM	Precip in/hr	
				■	▲
<b>40</b>	40	45'	7.0	0.67	0.77
	50	46'	8.0	0.73	0.84
	60	48'	8.5	0.71	0.82
<b>41</b>	50	52'	10.2	0.73	0.84
	60	53'	11.5	0.79	0.91
	70	54'	12.6	0.83	0.96
<b>42</b>	80	55'	13.5	0.86	0.99
	50	53'	11.0	0.75	0.87
	60	55'	12.3	0.78	0.90
<b>43</b>	70	57'	13.5	0.80	0.92
	80	59'	14.4	0.80	0.92
	50	58'	14.2	0.81	0.94
<b>44</b>	60	59'	15.5	0.86	0.99
	70	61'	16.3	0.84	0.97
	80	63'	18.1	0.88	1.01
<b>45</b>	60	65'	20.0	0.91	1.05
	70	66'	21.8	0.96	1.11
	80	68'	23.8	0.99	1.14
<b>45</b>	90	69'	24.9	1.01	1.16
	60	69'	22.0	0.89	1.03
	70	72'	24.3	0.90	1.04
<b>45</b>	80	73'	25.9	0.94	1.08
	90	74'	27.5	0.97	1.12

I-42 Nozzle Performance Data					
Nozzle	Pressure PSI	Radius ft.	Flow GPM	Precip in/hr	
				■	▲
<b>40</b>	40	41'	7.0	0.80	0.93
	50	42'	8.0	0.87	1.01
	60	42'	8.5	0.93	1.07
<b>41</b>	50	44'	10.2	1.01	1.17
	60	44'	11.5	1.14	1.32
	70	45'	12.6	1.20	1.38
<b>42</b>	80	46'	13.5	1.23	1.42
	50	46'	11.0	1.00	1.16
	60	47'	12.3	1.07	1.24
<b>43</b>	70	49'	13.5	1.08	1.25
	80	50'	14.4	1.11	1.28
	50	51'	14.2	1.05	1.21
<b>44</b>	60	52'	15.5	1.10	1.27
	70	52'	16.3	1.16	1.34
	80	53'	18.1	1.24	1.43
<b>45</b>	60	58'	20.0	1.14	1.32
	70	58'	21.8	1.25	1.44
	80	60'	23.8	1.27	1.47
<b>45</b>	90	60'	24.9	1.33	1.54
	60	60'	22.0	1.18	1.36
	70	62'	24.3	1.22	1.41
<b>45</b>	80	64'	25.9	1.22	1.41
	90	65'	27.5	1.25	1.45

I-40 Dual Opposing Nozzle Performance Data					
Nozzle	Pressure PSI	Radius ft.	Flow GPM	Precip in/hr	
				■	▲
<b>15</b> Gray	50	53'	13.0	0.45	0.51
	60	54'	14.3	0.47	0.55
	70	56'	15.5	0.48	0.55
<b>18</b> Red	80	58'	16.3	0.47	0.54
	50	60'	15.3	0.41	0.47
	60	61'	16.3	0.42	0.49
<b>20</b> Dk. Brown	70	62'	17.3	0.43	0.50
	80	64'	18.8	0.44	0.51
	60	66'	18.8	0.42	0.48
<b>23</b> Dk. Green	70	67'	20.0	0.43	0.50
	80	68'	21.5	0.45	0.52
	90	68'	22.4	0.47	0.54
<b>25</b> Dk. Blue*	60	67'	21.5	0.46	0.53
	70	68'	23.0	0.48	0.55
	80	69'	25.1	0.51	0.59
<b>28</b> Black	90	70'	26.0	0.51	0.59
	60	68'	21.0	0.44	0.50
	70	70'	25.0	0.49	0.57
<b>28</b> Black	80	72'	26.2	0.49	0.56
	90	74'	27.2	0.48	0.55
	70	72'	26.7	0.50	0.57
<b>28</b> Black	80	74'	27.9	0.49	0.57
	90	76'	30.1	0.50	0.58
	100	78'	32.0	0.51	0.58

\* Factory-installed nozzle

I-41 Nozzle Performance Data – Metric						
Nozzle	Pressure Bars	kPa	Radius m	Flow m³/hr	l/min	Precip mm/hr
						■ ▲
<b>40</b>	2.8	275	13.7	1.59	26.5	17 20
	3.4	344	14.0	1.82	30.3	18 21
	4.1	413	14.6	1.93	32.2	18 21
<b>41</b>	4.1	413	15.9	2.32	38.6	18 21
	4.1	413	16.2	2.61	43.5	20 23
	4.8	482	16.5	2.86	47.7	21 24
<b>42</b>	5.5	551	16.8	3.07	51.1	22 25
	3.4	344	16.2	2.50	41.6	19 22
	4.1	413	16.8	2.80	46.6	20 23
<b>43</b>	4.8	482	17.4	3.07	51.1	20 23
	5.5	551	18.0	3.27	54.5	20 23
	3.4	344	17.7	3.23	53.8	21 24
<b>44</b>	4.1	413	18.0	3.52	58.7	22 25
	4.8	482	18.6	3.70	61.7	21 25
	5.5	551	19.2	4.11	68.5	22 26
<b>45</b>	4.1	413	19.8	4.54	75.7	23 27
	4.8	482	20.1	4.95	82.5	24 28
	5.5	551	20.7	5.41	90.1	25 29
<b>45</b>	6.2	620	21.0	5.66	94.3	26 30
	4.1	413	21.0	5.00	83.3	23 26
	4.8	482	21.9	5.52	92.0	23 26
<b>45</b>	5.5	551	22.3	5.88	98.0	24 27
	6.2	620	22.6	6.25	104.1	25 28

I-43 Nozzle Performance Data – Metric						
Nozzle	Pressure Bars	kPa	Radius m	Flow m³/hr	l/min	Precip mm/hr
						■ ▲
<b>40</b>	2.8	275	12.5	1.59	26.5	20 24
	3.4	344	12.8	1.82	30.3	22 26
	4.1	413	12.8	1.93	32.2	24 27
<b>41</b>	3.4	344	13.4	2.32	38.6	26 30
	4.1	413	13.4	2.61	43.5	29 34
	4.8	482	13.7	2.86	47.7	30 35
<b>42</b>	5.5	551	14.0	3.07	51.1	31 36
	3.4	344	14.0	2.50	41.6	25 29
	4.1	413	14.3	2.79	46.6	27 31
<b>43</b>	4.8	482	14.9	3.07	51.1	27 32
	5.5	551	15.2	3.27	54.5	28 33
	3.4	344	15.5	3.23	53.8	27 31
<b>44</b>	4.1	413	15.9	3.52	58.7	28 32
	4.8	482	15.9	3.70	61.7	29 34
	5.5	551	16.2	4.11	68.5	32 36
<b>45</b>	4.1	413	17.7	4.54	75.7	29 34
	4.8	482	17.7	4.95	82.5	32 37
	5.5	551	18.3	5.41	90.1	32 37
<b>45</b>	6.2	620	18.3	5.66	94.3	34 39
	4.1	413	18.3	5.00	83.3	30 35
	4.8	482	18.9	5.52	92.0	31 36
<b>45</b>	5.5	551	19.5	5.88	98.0	31 36
	6.2	620	19.8	6.25	104.1	32 37

Note: All precipitation rates calculated for 180 degree operation. For the precipitation rate for a 360 degree sprinkler, divide by 2.

I-41 Dual Opposing Nozzle Performance Data – Metric						
Nozzle	Pressure Bars	kPa	Radius m	Flow m³/hr	l/min	Precip mm/hr
						■ ▲
<b>15</b> Gray	3.4	344	16.2	2.95	49.2	23 26
	4.1	413	16.5	3.25	54.1	24 28
	4.8	482	17.1	3.52	58.7	24 28
<b>18</b> Red	5.5	551	17.7	3.69	61.5	24 27
	3.4	344	18.3	3.46	57.7	21 24
	4.1	413	18.6	3.69	61.5	21 25
<b>20</b> Dk. Brown	4.8	482	18.9	3.91	65.3	22 25
	5.5	551	19.5	4.26	71.0	22 26
	4.1	413	20.1	4.26	71.0	21 24
<b>23</b> Dk. Green	4.8	482	20.4	4.54	75.7	22 25
	5.5	551	20.7	4.88	81.4	23 26
	6.2	620	20.7	5.09	84.8	24 27
<b>25</b> Dk. Blue*	4.1	413	20.4	4.88	81.4	23 27
	4.8	482	20.7	5.22	87.1	24 28
	5.5	551	21.0	5.70	95.0	26 30
<b>28</b> Black	6.2	620	21.3	5.90	98.4	26 30
	4.1	413	20.7	4.77	79.5	22 26
	4.8	482	21.3	5.58	94.6	25 29
<b>28</b> Black	5.5	551	21.9	5.96	99.4	25 29
	6.2	620	22.6	6.19	103.2	24 28
	4.8	482	21.9	6.06	101.1	25 29
<b>28</b> Black	5.5	551	22.6	6.34	105.6	25 29
	6.2	620	23.2	6.84	113.9	25 29
	6.9	689	23.8	7.27	121.1	26 30

\* Factory-installed nozzle

Note: All precipitation rates calculated for 360 degree operation.

## INSTALLATION & MAINTENANCE

### Installation Height

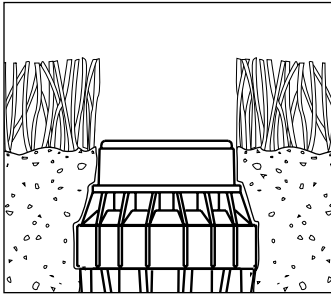

The I-40 sprinkler should be installed at finish grade as shown in the illustration above.

### Arc Adjustment

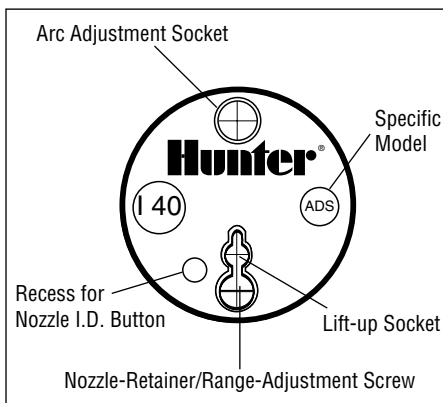

(All I-40 adjustable heads are PRESET to approximately 180°)

1. Rotate the nozzle turret counter-clockwise to the left stop.
2. Now, rotate the nozzle turret clockwise to the right stop. This is the fixed side of the arc. The nozzle turret must be held in this position for all arc adjustments.

### To increase arc:

1. Insert the key end of the Hunter wrench into the adjustment socket on top of the sprinkler.
2. While holding the nozzle turret at the right stop, turn the wrench clockwise.
3. Wrench will stop turning when adjusted to the maximum arc (360°).
4. Adjust to any arc between 40° to 360°.

### To decrease arc:

1. Insert the key end of the Hunter wrench into the adjustment socket.
2. While holding the nozzle turret at the right stop, turn the wrench counterclockwise.
3. Wrench will stop turning when adjusted to the minimum arc (40°).
4. Adjust to any arc between 40° to 360°.

### Nozzle Installation

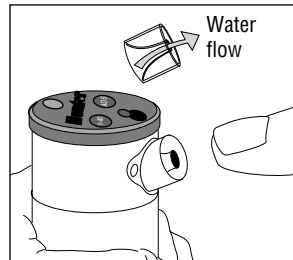

*Note: The special orientation of the nozzle with the open end of the "Funnel" facing inside the sprinkler.*

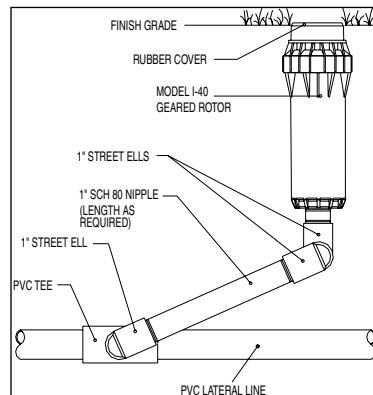

## DISTRIBUTION ANALYSIS

### *Hunter's Testing Philosophy*

The following six sets of distribution analysis for the I-40 are from Hunter's state-of-the-art testing lab. Hunter Industries routinely submits products to The Center for Irrigation Technology for independent testing. We use CIT's test results to verify our own and to make our performance available to the public through their computer software programs. All nozzles for the I-40 are tested by CIT. The examples below coincide with the six nozzles that are shipped with each sprinkler.

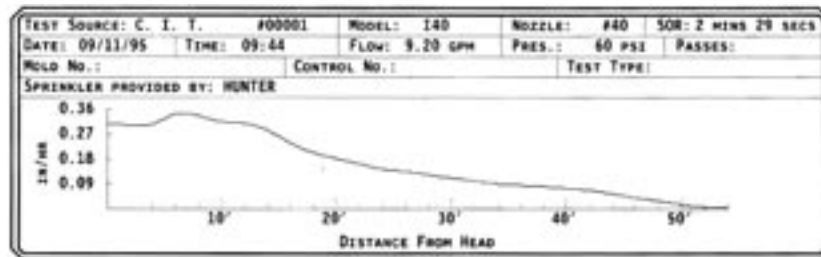

I-40  
Nozzle #40

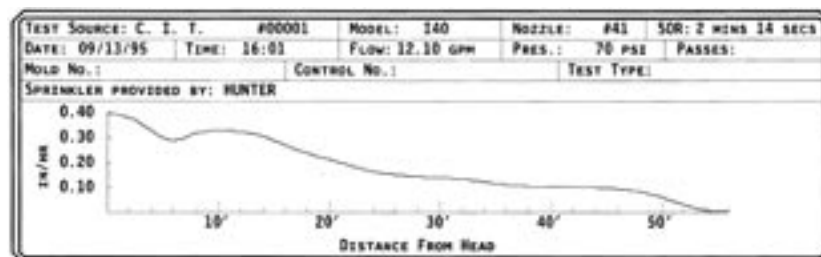
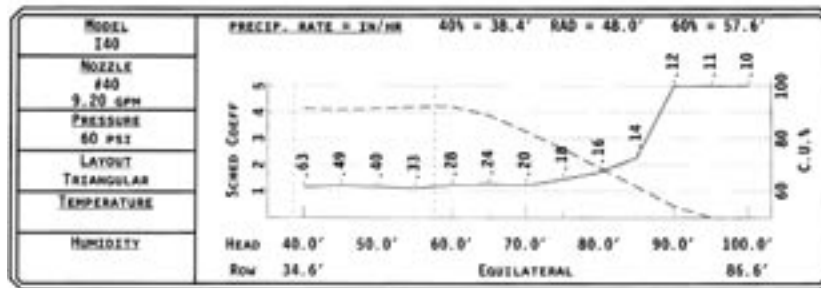

I-40  
Nozzle #41

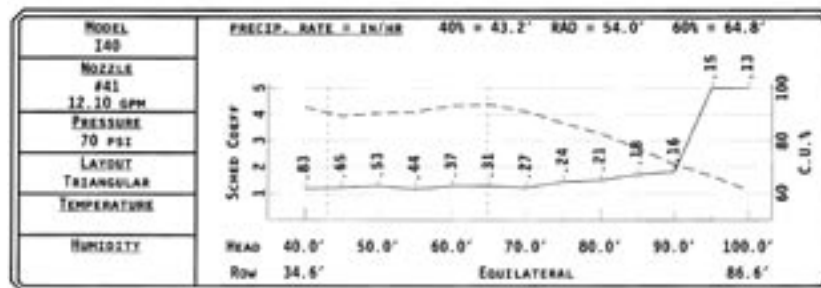

### Data Interpretation

The upper portion of each report shows the water distribution profile for the sprinkler along with flow, pressure and radius information. The lower portion is dedicated to efficiency and precipitation rate analysis. To read the graph, first note the spacing range at the bottom. These are the reference points when looking for efficiency at a specific spacing. The lower solid bar that has the numbers above it is the Scheduling Coefficient (SC) line. The numbers above this line reference the precipitation rate in inches per hour at each spacing. To find the SC at your spacing, reference the vertical numbers on the left. SCs of less than 2 are considered good and less than 1.5 are considered excellent. The dashed line along the top is the Coefficient of Uniformity (CU) line. The CU efficiency rating is no longer considered relevant for turf applications. It can be read by referencing the vertical numbers on the right. CUs above 80 are considered good and above 90 are considered excellent.

## DISTRIBUTION ANALYSIS (continued)

I-40  
Nozzle #42

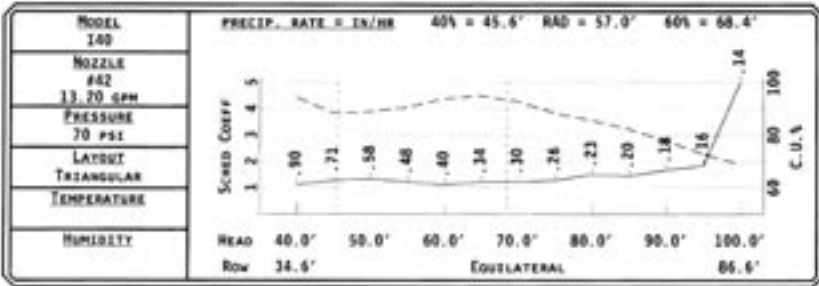
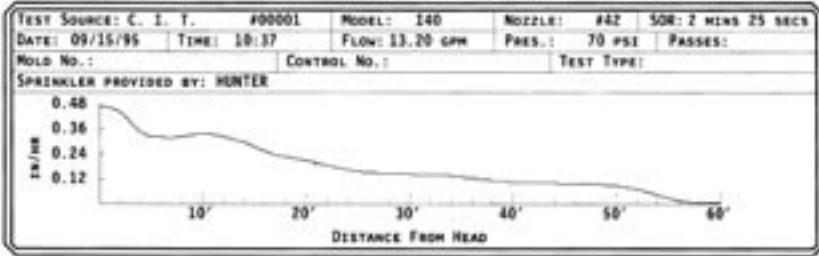

I-40  
Nozzle #43

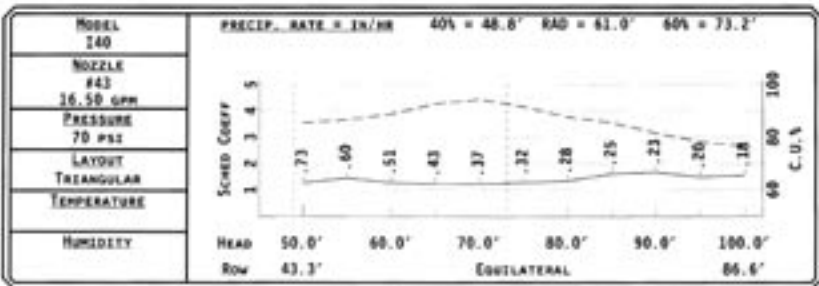
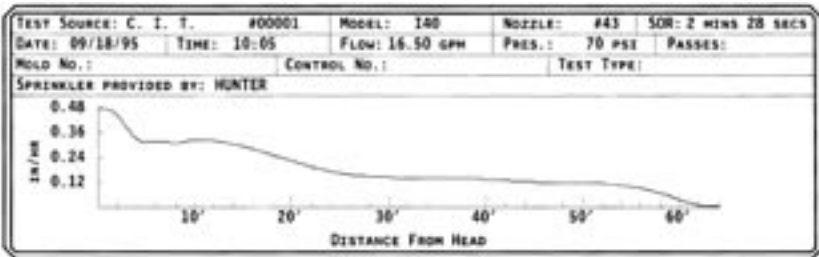

# I-40 Rotors

I-40  
Nozzle #44

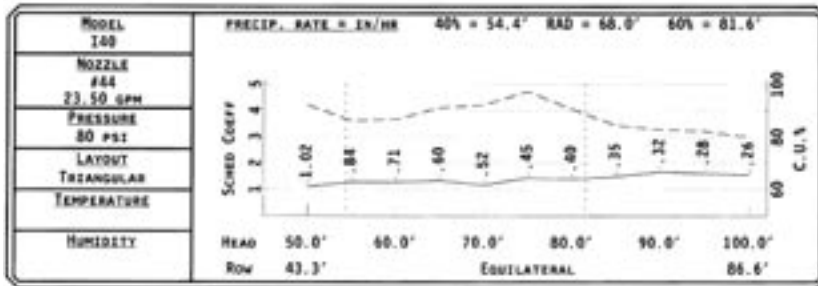
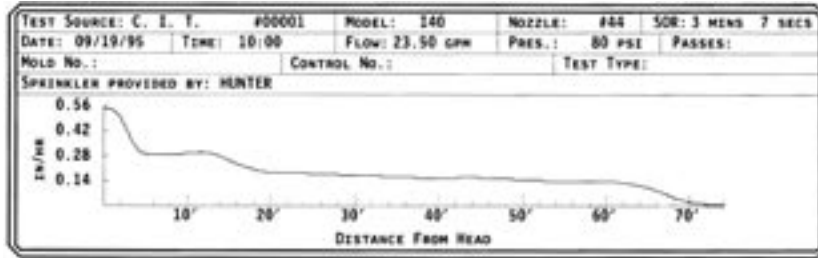

I-40  
Nozzle #45

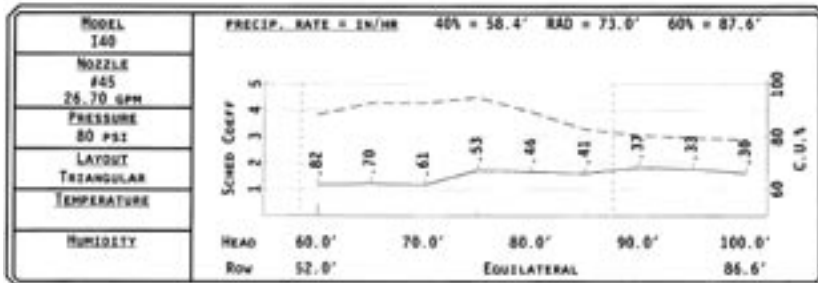
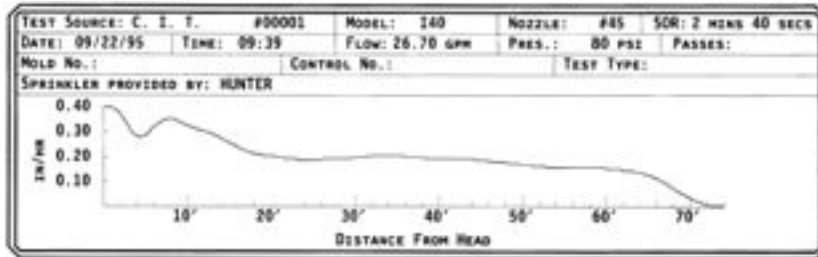

## I-40/41 REPLACEMENT PARTS

Item	Description	Catalog No.	
①	Nozzle Rack (6 Black)	ADS/36S	462458
		I40-ON	462459
②	Nozzle Retainer Screw	333900	
③	Diffuser Pin	245400	
④	Riser Assembly	I-40/41/44/45 – ADS, ARS	342200
		I-40/41/44/45 – 36S, 3RS	342300
		I-40/41 – 36S – ON	373100
		I-42/43 – ADS, ARS	343100
		I-42/43 – 36S, 3RS	343200
⑤	Filter Screen/Check Valve Assembly (White) <i>Date Codes 9410 and After – VStat</i>	303700	
⑥	Model Number Button	I-40	252705
		I-41	252715
		I-42	252720
		I-43	252725
		Blank	252735
⑦	Feature Designation Button	ADS	252805
		36S	252810
		ON	252850
		Blank	252845
⑧	Rubber Cover Screw (2 Required)	334000	
⑨	Rubber Cover Assembly <i>(Includes Part 10)</i>	Black	345005
		Brown	345010
		Purple	345015
⑩	Rubber Cover Washer	253000	
⑪	Body Cap Assembly	221600	
⑫	Riser Seal Slip Washer	221800	
⑬	Riser Seal	221200	
⑭	Spring Seat	221100	
⑮	Retraction Spring	221300	
⑯	Body	NPT	336405
		BSP	336410
⑰	Cup & Retainer Assembly – I-44 Turf Cup	344400	
⑱	Body Cap Assembly – I-44 Turf Cup	224600	
⑲	Turf Cup Kit – I-44 – Date Codes 9510 and After <i>(Includes Parts 17 and 18 Plus Instructions)</i>	460000	

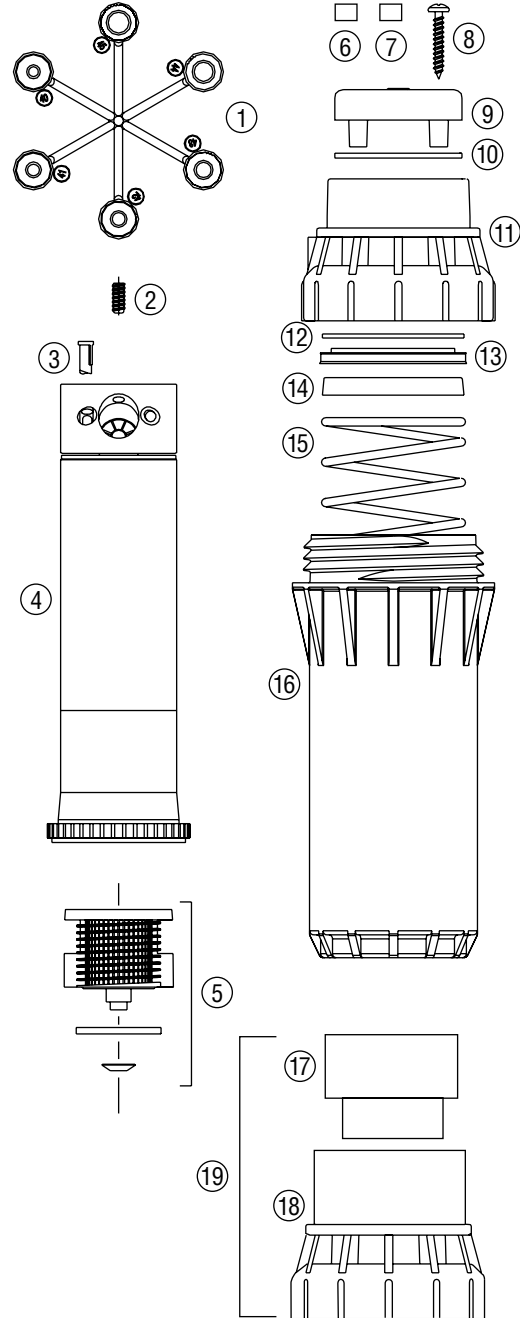



# Hunter®

**Hunter Industries Incorporated • The Irrigation Innovators**

1940 Diamond Street • San Marcos, California 92069 • TEL: (1) 760-744-5240 • FAX: (1) 760-744-7461  
[www.HunterIndustries.com](http://www.HunterIndustries.com)

© 2003 Hunter Industries Incorporated

P/N 700431 LIT-221 2/03